

ARTICLE 10
DUNE PROTECTION OVERLAY DISTRICT (DPOD) REQUIREMENTS

SECTION 1 INTRODUCTION

Dauphin Island is defined by its natural resources, one of which is the dune field. As a resilient natural barrier to the destructive forces of wind and waves, sand dunes are the most efficient defense against storm-surge flooding and beach erosion. Dunes absorb the impact of storm surge and high waves, preventing or delaying intrusion of waters into inland areas. Dunes hold sand that replaces eroded beaches after storms and buffer windblown sand and salt spray.

Beach and dune protection is important along the Alabama Gulf Coast, particularly in areas experiencing shoreline erosion and concentrated urban development. The growth of mainland coastal population centers and the increasing development and recreational use of the barrier islands can impact the stability of the dune environment. Construction and heavy recreational use of the beaches can contribute to fragmentation of the beach/dune system and deterioration of dunes. The vegetation that secures sand is destroyed, sand is lost, and the dune line is breached by roads, trails, and storm runoff. Dune damage that results from human activities accelerates the damage caused by wind and wave erosion. Inland areas become more vulnerable to hurricanes and tropical storms when the dune line is weakened. Protecting dunes helps prevent loss of life and property during storms and safeguards the sand supply that slows shoreline erosion. Protecting dunes also preserves and enhances the beauty of the coast and coastal ecosystems.

To succeed, dune improvement and protection efforts must be undertaken by federal, state, and local governmental entities. But even more valuable are efforts by those who live on the coast. Dauphin Island will continue to attract Alabamians and other visitors in ever-greater numbers for years to come. With this in mind, the Town of Dauphin Island created and adopted a Sand Dune Protection & Management Plan as an addition to the Comprehensive Plan including a Dune Protection Overlay District and Guidelines. With the adoption of the Dune Protection Overlay District (DPOD) to the Town's Zoning Ordinance #96, Article 10, the Town of Dauphin Island is working to ensure the long-term protection of the dunes.

SECTION 2 PURPOSE AND OBJECTIVES

The purpose of this article is to create and implement reasonable and responsible regulations that will protect the public investment in the beaches and dunes, and to protect public and private infrastructures. The regulations are intended to prevent harm or degradation to the valuable and protective sand dune resources from unauthorized foot or vehicular traffic, unauthorized digging, or other unnatural alteration of the dunes, unauthorized staging of construction materials or other unauthorized construction activity, installation of vegetation inconsistent with sand dunesystems, pet activity, or other unauthorized or disturbing activities that may lead to the gradual, immediate, or cumulative degradation of the natural or restored dune resources.

The Town's objective in this effort is to identify policies important in ensuring the integrity and functional values of the Island's sand dune system are not compromised by anthropogenic

alterations such as removal, leveling, excavation, vegetation degradation or removal, or placement of structures.

SECTION 3 LOCATION MAP OF DUNE PROTECTION OVERLAY DISTRICT



The official, adopted Zoning Map, showing the Dune Protection Overlay District is on file at Town Hall, Town of Dauphin Island, Alabama.

STREETS AND AREAS WHOLLY OR PARTIALLY ENCOMPASSED WITHIN THE
DUNE PROTECTION OVERLAY DISTRICT (DPOD):

1. PORTIER COURT
2. PONCHARTRAIN COURT
3. PONCE DE LEON COURT
4. BIENVILLE BOULEVARD
5. PEQUENO STREET
6. OLEANDER LANE
7. OLIVE LANE
8. OSPREY LANE
9. ORLEANS DRIVE
10. MONBERAUT PLACE
11. MISSISSIPPI STREET
12. LOUISIANNE AVENUE
13. LONGFELLOW PLACE
14. LASALLE STREET
15. ITASCA PLACE
16. IBERVILLE DRIVE
17. HUNLEY PLACE
18. HERNANDO PLACE
19. HERNANDO STREET
20. ISABELLA COURT
21. MALDANDO COURT
22. LENORA COURT
23. ARIAS COURT
24. GENERAL GORGAS STREET
25. GENERAL WILKINSON PLACE
26. FORT TOMBECBE PLACE
27. FORNEY JOHNSTON DRIVE
28. ADMIRAL SEMMES
29. BUCHANAN STREET
30. SAND CASTLE CONDOMINIUM
31. SURF CLUB
32. AUDUBON PLACE
33. AUDUBON STREET
34. AUDUBON BIRD SANCTUARY
35. AGASSIZ STREET
36. ANTARTIC DRIVE WEST
37. ANTARTIC DRIVE SOUTH
38. ANTARTIC DRIVE EAST
39. ADMIRAL STEWART CIRCLE
40. AUBURN UNIVERSITY SHELLFISH LABORATORY
41. ALBATROSS STREET
42. FORT GAINES

SECTION 4 GENERAL PROVISIONS

The following regulations generally apply to all properties located within the Dune Protection Overlay District (DPOD). The DPOD consists of lands south of Bienville Boulevard from the east end of the Island to the point where Bienville Boulevard narrows to two lanes, see DPOD Boundary Map in Section 3 of this Article for exact location.

Compliance With Other Laws: The Alabama Department of Environmental Management (ADEM) has statutory authority to regulate specific activities within their Coastal Area Jurisdiction of Dauphin Island. All properties located in the Dune Protection Overlay District are subject to the following regulations before the issuance of a Coastal Use Permit.

- A. In general, development within the Dune Protection Overlay District will use the same application and permits process used in all other areas of Dauphin Island. Additional requirements which are specific to the Dune Protection Overlay District are primarily focused on ensuring no degradation to the dune system or contour occurs. Toward this end there are more specific documentation requirements in the land survey and the Site Plan. A detailed process description and all deliverables are included in Section 12 of this Article.
- B. A Dune Protection Overlay District (DPOD) Site Plan Review Committee (SPRC) has been established with members consisting of Planning Commission, Board of Adjustment and Town Council members, as well as members from the citizenry of Dauphin Island. All applications within the Dune Protection Overlay District (DPOD) require review by the DPOD Site Plan Review Committee (SPRC) and the Dauphin Island Planning Commission.
- C. Permit Required: A Coastal Use Permitting Program has been established to protect the valuable beach and dune resources from adverse impacts associated with construction and other activities. A Coastal Use Permit shall be issued by the Building Official, and the permit fee required by this Ordinance shall be paid by the applicant before any new construction can begin or any modifications, alterations, extensions, or expansions can begin on an existing structure. A courtesy notice will be sent to adjoining property owners when an application for a Coastal Use Permit will be presented at a Planning Commission meeting for consideration and possible decision.
- D. Development activities in the DPOD are required to adhere to existing Town ordinances, which include:
 - Land Disturbance
 - Tree Removal
 - Flood Damage Prevention
 - Building Code
 - Sand Removal
 - Base Zoning
- E. Compliance Review Required: Any disturbance to the dune such as dune alteration, excavation, vegetation removal, and placement of structures, will be subject to inspection

by the Building Official to ensure any adverse impacts associated with construction and other activities have been rectified to the disturbed area of the dune. Any pre-approved construction-stage, temporary alteration of the dune or dune vegetation must be repaired after completion. If re-vegetation is necessary, the dune must be re-stabilized with native dune plants. These requirements must be completed, inspected, and approved prior to the issuance of a Certificate of Occupancy (CO).

- F. Maintenance: Encroaching sand from the dune system may be removed from lots but is required to be relocated within the dune system, provided that it is placed as near to the excavated site as practicable, as determined by the DPOD Site Plan Review Committee and Building Official. Each application for the removal of encroaching sand will be determined on a case-by-case basis. A plan including methods for sand removal, transport, and placement will be required to adhere to existing land disturbance regulations and permitting.
- G. Prohibited Activities: Any use or activity that impairs the natural function of the dune system or has the potential to cause significant adverse long-term impacts to the natural function of the dune system is prohibited, including the following. All prohibited activities are subject to the fines and penalties set forth in this Ordinance.
 - No person shall remove beach sands and/or vegetation or otherwise alter the contours of the dune system, between mean high tide and the area 25 feet seaward of the south toe of the dune system.
 - Paving, grading, or altering a dune within the footprint of the lowest floor of a structure in any manner will be prohibited.
 - No person shall operate a motorized vehicle of any type on the dune system except for official and/or emergency vehicles.
 - Removal of vegetation from any dune, and the excavation, bulldozing, or alteration of dunes are prohibited, unless these activities are a component of a Town-approved beach and dune management plan.
- H. All construction must incorporate 'Best Practices' methods. The dune system must not be mined, excavated, or altered such that the erosion and storm surge protection and ecological and aesthetic values afforded by them are diminished. Additionally, the following activities must be considered when constructing a structure on the dune:
 - Reducing sand height must be avoided
 - Excavation of dunes must be properly reviewed and permitted, and minimized to the greatest practicable extent.
 - Vegetation removal must be properly reviewed and permitted, and minimized to the greatest practicable extent.
- I. Any structure built on or over a dune will require at least two (2) feet of clearance above the portion of the dune within the structure footprint. Elevated dune walkovers shall be designed and constructed using ADEM Section 8 standards.

- J. All habitable structures may, with proper permitting, share a dune walkover with adjoining neighbors, pending review of a proposal for the shared walkover by the DPOD Site Plan Review Committee (SPRC) and Town of Dauphin Island Planning Commission.
- K. Due to the seasonal population of the Island, it is necessary to educate and inform visitors that the dunes are fragile and it is illegal to trespass on them. Signage must be installed and maintained on all dune walkovers to notify beach goers. Signs are provided by the Town of Dauphin Island and issued to property owner when an application for dune walkover construction is received. The SPRC will recommend proper placement of sign on property. This shall be notated on the Site Plan.
- L. Where the intent of the property owner is not to cross the dunes in any manner whatsoever, sand fencing is required at the property/dune interface and, a provision to prevent pedestrian traffic must be employed, e.g., signage stating that no crossing of the dunes is allowed.

THIS PAGE INTENTIONALLY LEFT BLANK

SECTION 5 DEFINITION OF DUNE TERMS

The following words and terms, when used in this regulation, have the following meaning unless the context clearly indicates otherwise.

Accidental Event means a sudden, unintended, and unexpected occurrence that results in damage or loss of property.

Act of God means a sudden and inevitable occurrence caused by natural forces and not by the agency of man, such as a flood, earthquake, or a similar catastrophe.

ADEM means Alabama Department of Environmental Management.

Alter means to means to change an existing structure for purposes other than to enhance its integrity or value.

Beach means that area which extends from the mean high-water line of the Gulf of Mexico and Mobile Bay landward 1,000 feet and seaward 2,500 feet, respectively.

Berm means a level space, shelf or raised barrier (usually made of compacted soil or deposited sand) separating two areas. It can serve as a fortification line, a border/separation barrier, or in many other applications.

Buildable Lot means a lot upon which construction of a structure is permissible by all State, Federal, and local codes and regulations.

Building means any roofed and walled structure built for permanent or semi-permanent use.

Bulkhead means an upright structure or partition built parallel or nearly parallel to the shoreline, primarily to retain or prevent land from sliding and secondarily, to protect upland from beach erosion and damage from wave action.

Caliper means diameter of a stem 6 inches above the nursery planting line.

Contour means an imaginary line on the land surface that connects points of equal elevation.

Construction Control Line (CCL) means a line generally paralleling the coast, seaward of which construction of any kind shall be prohibited without a permit or letter of approval.

Coastal Use Permit means the permit obtained to perform any land disturbance, tree removal, new construction and/or alterations in the 'Dune Protection Overlay District' of Dauphin Island, AL.

Construction means any work or activity which is likely to have a material physical effect on existing coastal dune conditions and processes.

Damage to Dunes means, including, but not limited to, any alteration of the existing characteristics of the dune that could significantly increase the danger of erosion, storm damage or flooding and includes the moving, digging, or removal of beach or dune, or the erection of any temporary or permanent structure without the first obtaining an authorized permit.

Deck means an open platform extending from a house or other building.

Diameter Breast Height (DBH) means the measurement method you use to measure a tree. At 4-1/2 feet above the ground, wrap a measuring tape around the trunk of the tree. Divide the measurement by 3.14 to get the diameter, also known as DBH (diameter at breast height). On steep slopes, measure this distance on the uphill side of the tree. Trees with multiple tree trunks should be treated as multiple trees and the DBH of each trunk added to the aggregate diameter measurement.

Dune means a mound, hill or ridge of windblown sand, either bare or covered with vegetation, naturally or artificially accumulated.

Dune Crest means the highest land of any dune.

Dune Protection Overlay District (DPOD) means the properties lying within the DPOD and shown on Zoning Map.

Dune Protection Overlay District Site Plan Committee means a committee consisting of members of Planning Commission, Town Council, and Board of Adjustment created to oversee the application and permit process for construction in the DPOD.

Dune Toe means the lowest point on a slope of a dune or bluff.

Dune Walkover means an elevated walkway or boardwalk constructed over a sand dune to allow pedestrian access without causing damage to the dune itself.

Edge Effect means changes in population or community structures that occur at the boundary of two or more habitats. Areas with small habitat fragments exhibit especially pronounced edge effects that may extend throughout the range.

Emergency means any unusual incident which endangers the health safety or resources of the general public, including damages or erosion of any shoreline resulting from a hurricane, storm, or any such natural disturbance.

Encroaching Sand means the natural movement and accumulation of sand where prevailing onshore winds blow sand inland. This action causes sand particles to “migrate” inland, as it does so it accumulates and advances beyond proper, established, or usual limit.

Erosion means the wearing away of land or the removal of beach and/or dune material by wave action, tidal currents, littoral currents or deflation. Erosion includes but is not limited to horizontal recession and scour and can be induced by human activities.

Excavation means the process of digging out material.

Expansion means the enlargement of a structure.

FEMA means the Federal Emergency Management Agency of the United States Government. This agency administers the national Flood Insurance Program and the Flood Insurance Rate Maps.

Fill means a deposit of earth material placed by artificial means.

Filling means the process of depositing or placing material to raise the level of a certain area or to change the type of soil of the area.

Footprint means the perimeter of the area occupied by the structure including any roof overhangs, decks, stairways, or other permanent attachments.

Fragmentation means the process whereby a large patch of habitat is broken down into many smaller patches of habitat, resulting in a loss in the amount and quality of habitat.

Geology means the relationship of the earth and the materials of which it is composed, to the changes which it has undergone, is undergoing, or is likely to undergo.

Hydraulics means the effects of water or other fluids in motion.

Improve means to change an existing structure in order to enhance its integrity or value.

Interdunal Pond means a water-filled depression between coastal sand dunes.

Interdunal Wetland means a water-filled expanse of area between coastal sand dunes. They typically remain inundated with water and are very shallow and provide an abundant source of invertebrates eaten by many species of shorebirds. Many interdunal wetlands are ephemeral, drying out during periods of low rain or low water.

Land Disturbance means any alteration to the natural state of a piece of land.

Littoral means pertaining to the shore of a sea.

Littoral Drift means material such as sand and stones moved near the shore in the littoral zone under the influence of waves and currents.

Lowest Habitable Floor means the lowest portion of the lowest horizontal support member of the lowest enclosed space used for living purposes, which includes working, sleeping, eating, cooking,

recreation, or combination thereof. A floor used only for storage shall not be considered a habitable floor.

Maintenance (Maintenance Activities) means those activities involved with repairing and/or renovation existing structures and those that do not alter or increase the foot print of existing structures. Adversely impact dunes and/or dune vegetation. Maintenance activities include, but are not limited to: repairing or replacing siding, steps, roofs, windows, doors, fences, sidewalks, dune walkovers, landscaping.

Mast or Mastig means is the production of many seeds by a plant every two or more years in regional synchrony with other plants of the same species.

Material Physical Effect - See Damage to Dunes.

Modification means a partial change in the form of a structure.

Niche means a unique ecological role of an organism in a community.

North American Vertical Datum (NAVD) means a fixed reference adopted by the U. S. Government as a standard geodetic datum for vertical elevations.

Observation Deck means a deck constructed to stand alone away from other structures and used for observation.

Repair means the act of restoring a structure to good condition after it has been damaged. Repair does not mean expansion or modification of a structure.

Retaining Wall means a structure designed primarily to contain material and to prevent the sliding of land.

Sand Barren means an area of exposed sand with short trees, shrubs, and grasses.

Sand Dune Protection and Management Plan means the plan adopted by the Town of Dauphin Island as Appendix A of the Comprehensive Plan, for the purpose of imposing reasonable regulations that will protect the public investment in the beaches and dunes, and to protect public and private infrastructures. The regulations are intended to prevent harm or degradation to the valuable and protective sand dune resources.

Sand Fence means a barrier made of posts, wires and boards or synthetic materials including plastic, nylon, and polyester intended primarily to trap and collect wind-blown sand, but which may also be used to channel human and vehicular traffic.

Shoreline means the line of intersection of a body of water with the land.

Site Plan Review Committee (SPRC) means a committee established by the Town of Dauphin Island to provide assistance with the development process within the Dune Protection Overlay District (DPOD) and oversee and review all applications within the DPOD.

Slope means a part of the side of a dune, the surface of which at one end or side is at a higher level than another; a rising or falling surface.

Substantial Amount means any amount, the moving, alteration, or removal of which could significantly increase danger of erosion, storm, damage, or flooding.

Substantial Change means any alteration in the existing characteristics of the dune that could significantly increase the danger of erosion, storm damage or flooding and including the moving, digging, or removal of beach material or the erection of any permanent or semi-permanent structure.

Temporary Structure means any not permanent, non-habitable structure that can be easily removed from the site within a short time frame using minimal equipment and man power. Examples include, but are not limited to, signs, benches, sheds, ramps, steps, or walkways.

Vegetation means all the plants or plant life of a place, taken as a whole.

Wattle means logs created of straw and wood and contained in a fabric sheath and are used as an erosion and sediment control device. Wattles assist in stabilizing disturbances by shortening the slope lengths, reducing water flow velocities, and sand movement by trapping sediment.

THIS PAGE INTENTIONALLY LEFT BLANK

SECTION 6 ALLOWABLE USES AND ACTIVITIES

All uses allowed in the underlying zoning districts encompassed within the Dune Protection Overlay District (DPOD), which are classified as *Uses Permitted*, *Uses Requiring Review*, or *Special Exceptions*, are allowable uses in the DPOD. Refer to Article 6: District Requirements section of this Ordinance for uses allowed in each zoning district. All applications within the DPOD require review and approval by the DPOD Site Plan Review Committee and the Dauphin Island Planning Commission before the issuance of a building permit.

The following list of activities are allowed activities within the DPOD. All activities within the DPOD require review by the DPOD Site Plan Review Committee and the Planning Commission:

- The construction and maintenance of walkways which do not alter the contour of the sand dunes;
- The construction and maintenance of observation platforms and/or piers which are not an integral part of any dwelling and which do not alter the contour of the coastal sand dunes;
- The planting of beach grasses or other appropriate dune vegetation for the purpose of stabilizing sand dunes;
- The placement of sand fences on or adjacent to sand dunes for the purpose of stabilizing and enhancing the formation of such features;
- The conservation and research activities of the Dauphin Island Sea Lab, Alabama Department of Conservation and Natural Resources, Audubon Society, Dauphin Island Park and Beach Board and other conservation, and research-related agencies and entities; provided that said activities have no construction or excavation components, or would otherwise alter the contour of the coastal dunes.

THIS PAGE INTENTIONALLY LEFT BLANK

SECTION 7 SITE PLANNING REQUIREMENTS APPLICABLE TO ALL CONSTRUCTION

Excavation volumes causing impacts to steep slopes are a direct measure of the extent of disturbance and can change the essential character of the dunes. Sand that is not contained and is disturbed is subject to wind and rain erosion, which can lead to creation of a dune blowout and spreading damage.

Construction impacting slopes of 15 degrees (15°) or greater must incorporate the following management practices that minimize the amount and disturbance of soils as part of planning, construction, and long-term stabilization of the site.

The following are guidelines on minimizing impacts to the dune system.

A. Minimizing Disturbed Area:

- In the Dune Protection Overlay District thirty percent (30%) of the total area of the lot shall remain undisturbed and its natural condition. This requirement supports soil stabilization on the lot while ensuring proper storm water provisions have been met.
- Construction and development must, wherever possible, avoid areas with slopes greater than 30 degrees (30°).
- Utilize areas that will not affect the dune slope. The Planning Commission may recommend setback adjustments in order to protect dune slopes.
- Utilize areas that may have been previously cleared or graded for construction.
- The SPRC shall recommend a minimum construction setback for equipment movement or storage. In no case, should this include areas with greater than a 30 degrees (30°) slope. A temporary fence or other type of demarcation method shall be installed to identify the construction boundary.
- Locate residential structures as close to the street as possible.
- Eliminate or minimize all impervious surfaces.
- The development of a plan for a driveway should include consideration of the use of retaining walls or similar measures, if feasible, to minimize the impact of the driveway, parking, turnaround areas, etc. on the lot. Driveways will be limited to fit within the linear width of the primary structure, and it is strongly recommended that driveways utilize permeable materials that provide maximum porosity and drainage to mitigate erosion caused by stormwater (surface water flow). If an existing driveway needs to be re-graded, it must be regraded within the existing driveway footprint/corridor (no expansion of width or length).

B. Minimizing Impacts to Ecological Communities:

- Avoid impacts to areas of ecological significance (interdunal pond/wetland, sand barren, open dunes, vegetation).
- Maintain continuity of vegetation (minimizing edge effect).
- Utilize demarcation fencing to isolate critical areas (wetlands, watercourses, vegetation protection).
- Construction equipment traffic must be minimized

C. Minimizing Soil Movement:

- Limit the difference between cut and fill volumes balancing volumes of like material on site.
- Do not bring new fill on the site as it may bring invasive, exotic (non-native) seeds or damaging fungus. Removing soils removes seeds of native plants and any topsoil and organic material from the site.
- Limit impacts that facilitate slope failure and erosion, including control of stormwater and impacts to slopes offsite. Utilize erosion control measures at both the bottom of the slope (to protect uphill from construction) and at the top of the slope (to protect areas downhill from construction occurring along the crest of a slope).
- Demarcate limits of clearing, grading and vegetation removal to avoid accidental damage to slopes and vegetative roots that support slopes. Demarcation discourages materials and equipment from being stored, used or driven outside the impact area. Said demarcation will be accomplished prior to any land disturbance, tree removal or construction, and will be documented by the Town of Dauphin Island Building Official with photos prior to permit issuance.
- Utilize a park-and-walk scenario with a boardwalk, stairway, or lift for access if constructing a driveway would impact dune slope.

D. Minimizing Impacts from Utilities:

- Utilize underground utility corridors in new construction projects (adjacent to access roadways) and impact slopes 15 degrees (15°) or less.
- Utilize hand trenching for utilities in projects covering relatively short distances and impact slopes 30 degrees (30°) or less. Ensure soils from trenching can be safely staged adjacent to trenching without impacting slopes or vegetation.

E. Minimizing Tree and Vegetation Removal:

In addition to the existing tree removal permit process the following shall apply:

- Plot location of all trees over 4" DBH in the site plan.
- No clearing of trees or vegetation on slopes and outside construction buffer areas.
- Do not remove trees or vegetation which are located more than 10 feet from proposed buildings; and no more than 5 feet from decks and along driveways.
- Demarcate limits of clearing, grading, and vegetation removal to avoid accidental damage to slopes and vegetative roots that support slopes.
- Stockpile material from excavation areas and utilize for redistribution on the site. This provides a local seed source of native species.
- Avoid removal of trees and shrubs that may impact unique natural features in the area, including: ponds, seeps, springs, foredunes, or dune ridges.
- Maintain large diameter trees (greater than 12" DBH).
- Maintain mature trees (seed/mast producing) outside of structure and driveway footprint.
- Maintain trees and shrubs that would improve or maintain the natural diversity of the site.

- Minimize the amount of edge created.
- Maintain tree communities that provide necessary niches within bigger landscape.
- Avoid removal of trees / shrubs that may impact unique natural features in the area including: ponds, streams, seeps, springs, dune ridges, or areas with high densities of wildflowers.
- Avoid removal of trees / shrubs in areas that contain endangered or threatened plants (i.e., sea oats).

THIS PAGE INTENTIONALLY LEFT BLANK

SECTION 8 APPLICATION AND REVIEW PROCESS TO OBTAIN A COASTAL USE PERMIT

All activities associated with the Dune Overlay District will be reviewed by the Dune Protection Overlay District (DPOD) Site Plan Review Committee (SPRC) and the Town of Dauphin Island Planning Commission prior to making a determination of authorization if otherwise allowable by law.

Upon receipt of an application package, it will be forwarded to the SPRC Committee and the Planning Commission by the Town of Dauphin Island.

The following is a list of the necessary steps to complete the Dune Protection Overlay District Application process to obtain a Coastal Use Permit. The site plan checklist following this section designates what deliverables are required.

1. Determine if the property lies within the Dune Overlay Protection District. A map of the Dune Protection Overlay Zone is shown in Section 3 of this Article. The official zoning map for the Town of Dauphin Island is located at Town Hall.
2. Obtain a Coastal Use Permit Application Package from Dauphin Island Town Hall.
3. Schedule a pre-application meeting and site visit with the DPOD Site Plan Review Committee (SPRC). The property owner/authorized agent (authorization form required) is required to be present at the meeting and site visit. The SPRC will require an accurate diagram of property. Following the meeting, the SPRC will conduct a site visit and conference with the owner or authorized agent to instruct and assist the applicant on all required documents and processes necessary to obtain a Coastal Use Permit.
4. Submit Application Packets and accompanying fees. A completed application package must contain all items on Dune Protection Overlay District checklist, see Section 12 of this Article for all required documentation.
5. Ensure site is staked with metal stakes to include property boundaries, proposed structure corners, driveway and other areas of proposed impact prior to the initial site visit. The SPRC will schedule a second site visit within 10 business days of receiving completed application packet. By scheduling a site visit, the SPRC and staff will be allowed full access to the property. During the site visit the property owner / authorized agent is required to be present to discuss options and assurance criteria.
6. Upon completion of the site visit review the SPRC will provide the property owner / authorized agent with opinions and recommendations. All materials will be mailed to the property owner / authorized agent within seven (7) business days after completing the plan review.
7. SPRC opinions and recommendations along with the Building Official opinions and recommendations are delivered to the Planning Commission for review.
8. Site Plan Review is added to the Planning Commission agenda and scheduled for next regularly scheduled Planning Commission Meeting, provided a completed application packet is returned by the Planning Commission meeting cut-off date.
9. Courtesy notice is given to adjoining property owners of Planning Commission meeting.

10. Action taken by the Town of Dauphin Island Planning Commission unless additional changes are needed. If substantial additional changes are needed, the action may be tabled to the next Planning Commission meeting.



Town of Dauphin Island, Alabama

SURVEY & SITE PLAN CHECKLIST for DUNE PROTECTION OVERLAY DISTRICT

All surveys and site plans must include the following required elements to be considered for site plan review by the DPOD Site Plan Review Committee and the Dauphin Island Planning Commission.

- Surveys shall be prepared, signed, and sealed by a surveyor or an engineer, currently licensed in the State of Alabama.
- All Site Plans shall be prepared, signed, and sealed by a surveyor or licensed professional engineer, currently licensed in the State of Alabama.
- All Site Plans must be drawn to a scale of not smaller than 1 inch = 20 feet.
- All sites must be staked using metal stakes.

Survey

- 1) _____ Property Address;
- 2) _____ Name, address, and contact information of property owner or authorized agent;
- 3) _____ Name and contact information of surveyor or engineer, (including current license numbers);
- 4) _____ Date of survey;
- 5) _____ Location map;
- 6) _____ Scale and north arrow (pointing north);
- 7) _____ Parcel number of each lot;
- 8) _____ Size in square feet of parcel(s);
- 9) _____ Flood zone designation;
- 10) _____ Front, side, rear, and waterside yard setbacks, if applicable;
- 11) _____ USGS - MSL – Elevation contours at 5 ft. intervals for slopes of 15° or greater;
- 12) _____ Adjacent properties, streets, service roads, curbs and dimensions of same;
- 13) _____ Means of ingress and egress to and from the property, to include traffic flow diagrams;
- 14) _____ All trees 4" DBH or larger identified by size species and location.

Site Plan

- 15) _____ Zoning classification(s) of site;
- 16) _____ Existing and proposed buildings, location, position on lot, size and dimensions of each;
- 17) _____ Proposed use of buildings;
- 18) _____ Number of dwelling units, commercial units and density of units per lot;
- 19) _____ Distance, in feet of proposed structure(s) from all property lines (front, rear, sides, and waterside);
- 20) _____ Stormwater management including runoff during construction (i.e., pile jetting water);

- 21) _____ Erosion and sedimentation plan (during and after construction), to include protection measures to be employed to protect man-made and natural drainage ways and adjacent properties;
- 22) _____ Number of required off-street parking spaces (including handicapped), location, and size of each;
- 23) _____ Off-street loading and unloading areas (non-residential only);
- 24) _____ Location and specifications of all utilities. Utility and right-of-way easements;
- 25) _____ Landscaping plan showing required Dune Protection Overlay District landscaping;
- 26) _____ Location, dimension, and number of all on-premise signs;
- 27) _____ Location of lighting on property not attached to a structure;
- 28) _____ Location of garbage disposal facilities and screening (if applicable);
- 29) _____ Location of required buffers or fences (if applicable); Details on any proposed fencing and/or retaining walls to be constructed, both temporary and permanent;
- 30) _____ Required thirty percent (30%) minimum of undisturbed areas that are to remain on the property;
- 31) _____ Details on proposed property enhancements such as dune walkovers, sidewalks, trails, walkways, open space, etc.;
- 32) _____ Location of required signage, if applicable;
- 33) _____ Signed statement of Best Management Practices used in design and construction plans by Professional Engineer/Licensed Architect;
- 34) _____ Construction and design details of all proposed and/or altered buildings and structures including:
 - Building orientation
 - Floor plan
 - Roof plan and overhangs
 - Yard setbacks, encroachments and/or projections
 - Height of building
 - Foundations - Type, size, and location of pilings, as well as the installation method must be specified in the construction plans by a Licensed Professional Engineer.
 - Elevation view of the property being developed, to include the first-floor elevations of the proposed structure(s).
 - Exterior design details, including specific materials existing/planned for use on buildings and structures, with their locations indicated on the elevations;
- 35) _____ Tree Removal Plan inclusive of mitigation details;
- 36) _____ Approval by the Dauphin Island Water and Sewer Authority as to availability and capacity of services to site;
- 37) _____ Signature block for all required signatures.

SECTION 9 SUGGESTED BEST MANAGEMENT PRACTICES

All construction must incorporate Best Management Practices (BMPs). A site can be planned and a home can be designed so that the natural setting is superbly preserved only to have the site significantly and unnecessarily damaged by poor construction practices and methods.

The structure and access to the structure must be in accordance with site plans and certifications prepared and sealed by a registered, certified Professional Engineer licensed in the State of Alabama. ***A signed statement of Best Management Practices used in design and construction plans by a Professional Engineer and/or Architect licensed in the State of Alabama must accompany the Site Plan.*** Site plans and certifications for any proposed structures must meet all local, state and federal regulatory agency guidelines and procedures.

The following suggested techniques described in detail below were taken from the following sources: **Federal Emergency Management Agency's (FEMA) *Local Officials Guide for Coastal Construction: Design Considerations, Regulatory Guidance, and Best Practices for Coastal Communities FEMA P-762 / February 2009* ; *Alabama Department of Environmental Management's (ADEM) Section 8 Standards For Dune Walkover Construction*; and *The Dune Protection and Improvement Manual of the Texas General Land Office* .**

A. General Provisions:

The dune system must not be mined, excavated, or altered such that the erosion and storm surge protection and ecological and aesthetic values afforded by them are diminished. Within the area of the dune system:

- The dune crest shall not be reduced in elevation.
- Excavation of dunes must be properly reviewed and permitted, and minimized to the greatest practicable extent.
- Vegetation removal must be properly reviewed and permitted, and minimized to the greatest practicable extent.

Minimization will include alternative site plans designed to avoid direct or indirect destabilization of the dunes, including the location and configuration of habitable structures, stormwater conveyance, bulkheads, driveways, and appurtenances. Suspension of required Zoning Ordinance setbacks will be considered in some cases within the Dune Overlay District in an effort to reduce adverse impacts to the dune system.

Any pre-approved construction-stage, temporary alteration of the dune or dune vegetation must be repaired after completion. If re-vegetation is necessary, the dune must be re-stabilized with native dune plants. These requirements must be completed, inspected and approved prior to the issuance of a Certificate of Occupancy.

B. Building Design

1. The house and other structures should have as small a footprint as possible, thus leaving as much of the native environment undisturbed as possible. Use multiple floors. Smaller

footprints also mean smaller impervious areas and thus pose less of a threat of erosion from rainwater runoff while preserving more of the

2. Acquire adequate land for the proposed structure. To avoid destroying the beauty that draws one to the dunes, be careful to not build "more house" than can be accommodated comfortably on the site.
3. "Think out of the box". For example, a roof deck can provide greater views without additional disturbance to the site.

C. Stabilization of Slopes

Development in critical dune areas often requires slope stabilization to minimize impacts and avoid creation of erodible soils. The use of retaining walls for slope stability allows for increased elevations within a short distance; however the design and use must provide resistance to the lateral pressure of the soil. Additional wall support may be achieved through use of mechanical anchors. Protect and mitigate all impacts to slopes during construction, and stabilize slopes following completion of all activities. Soil stabilization and soil erosion techniques are utilized to minimize soil movement at the source and limit sedimentation issues. Appropriately designed and installed techniques can eliminate soil erosion, reduce sediment pollution, minimize future impacts to slopes. Long-term stabilization in the form of plantings, wattles and fencing are strongly encouraged and, in some cases, required.

D. Temporary Slope Stabilization During Construction

1. Install geotextile fabric fence (silt fence) parallel to contours in areas with 15 degree (15°) slopes and ensure appropriate installation distance at a minimum of two (2) feet from the toe of a 15 degree (15°) rise.
2. Install plywood sheeting parallel to contours in areas with 30 degree (30°) slopes and ensure a minimum installation distance of no less than three (3) feet from toe of a (30°) rise.

E. Permanent Slope Stabilization

1. Minimize erosion from rainwater run-off. Avoid use of single point of discharge (e.g., a downspout or an area drain discharge pipe). A concentrated source can easily deliver water faster than the ground can absorb it and cause erosion. A sheet of water draining from a roof or large paved area is also likely to cause erosion. In both cases, it is necessary to disperse the flow over a wide, flat area so that the water is slowed and a portion absorbed. Or use rain barrels to safely collect runoff.
2. Utilize the construction of dune walkovers for stabilization of dune slopes where pedestrian traffic will take place. Where the intent of the property owner is not to cross the dunes in any manner whatsoever, sand fencing is required at the property/dune interface and, a provision to prevent pedestrian traffic must be employed. A sign stating that no crossing of the dunes is allowed will be given to each property owner and must be posted.
3. Utilize wattles made of straw and wood as an erosion and sediment control device.

4. Utilize appropriate retaining wall structure with tiebacks to inhibit wall failure, slumping, and soil seepage.
5. Install all slope stabilization structures (temporary and permanent) prior to beginning other construction activities onsite to protect slopes from incidental damage.

F. Dune Walkover Construction

1. To prevent damage to dunes, all developments will be required to provide a beach access walkover that adopts ADEM Section 8 standards.
2. All habitable structures may, with proper permitting, share a dune walkover with adjoining neighbors, pending review of a proposal for the shared walkover by the Town of Dauphin Island Planning Commission. Where the intent of the property owner is not to cross the dunes in any manner whatsoever, sand fencing is required at the property/dune interface and, a provision to prevent pedestrian traffic must be employed, e.g., signage stating that no crossing of the dunes is allowed, etc.
3. A walkover should begin landward of the foredune and extend no farther seaward than the most landward point of the public beach where it will not interfere with public use of the beach at normal high tide. The structure should be oriented at an angle to the prevailing wind direction. Otherwise, wind blowing directly up the path of the walkover may impede the growth of vegetation beneath it, erode sand from the seaward end, and increase the possibility of washout or blowout occurrences.
4. Construction Material- Wood is the preferred construction material for walkovers because it is less expensive than metal, does not collect and retain heat as metal does, and is readily adapted to a number of designs. Although there are a few walkovers made from polyvinyl plastic, treated lumber and galvanized nuts and bolts may be used.
5. Size- The width of a walkover should be based on the expected volume of pedestrian traffic. If a walkover will be infrequently used, a width of two feet should be sufficient. Walkovers intended for two-way passage should be wider, perhaps three or four feet. A width of six feet may be appropriate for a walkover subject to heavy use. The structure's height should be at least one to one and a half times its width (three feet minimum) to allow sunlight to reach vegetation underneath. In any case, the deck of the walkover must be of sufficient elevation to accommodate the expected increase in dune height. Basic structural guidelines for walkovers are detailed in *Figure 1*.
6. Construction Guidelines- Space the slats forming the deck of the walkover 1/2 inch apart so that sunlight and rainfall can

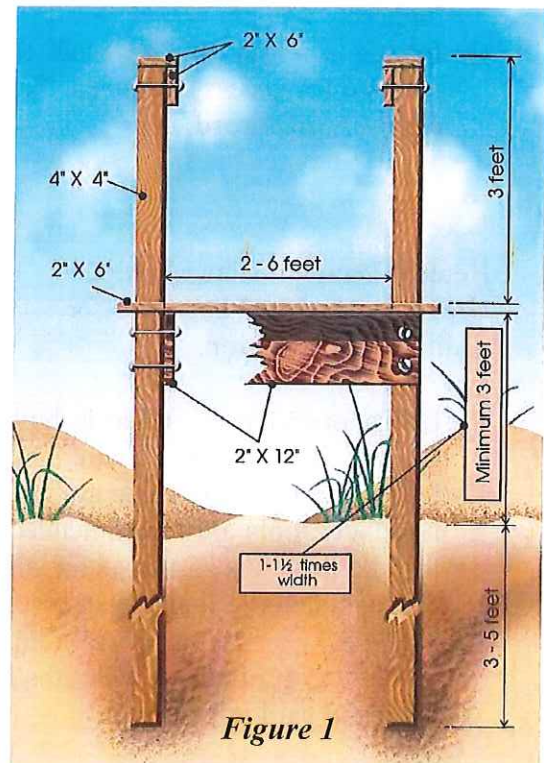

Figure 1

penetrate to plants below and so that sand will not accumulate on the deck.

7. Place the supporting piers as far apart as possible along the length of the structure. A distance of at least six feet between pairs of piers is recommended. Implant the piers at least three feet in the ground to ensure stability. A depth of five feet or more is advisable to allow for erosion around the piers during storms. Install the piers with a hand auger or posthole digger rather than with a tractor. Walkover piers should not be set with cement. Repair damage to the dune area as soon as possible.
8. Providing handrails on both sides of the walkover is recommended as a safety measure and to discourage people from jumping off into the dunes. Railings are particularly advisable on public walkovers and those that are high above the ground. Railings should be at least three feet high.
9. To enable wheelchair use on a walkover, inclined ramps with a 20 percent slope (a one-foot rise for every five feet in length) may be built at each end of the structure. Ramps are recommended for any large public walkover.

10. Design- See Dune Walkover Designs in Figure 2.

- Design A has a flat deck with steps at each end.
- Design B has ramps instead of steps, and the deck is arched where dune formations are highest.
- Design C may be adapted to suspend for access over areas that cannot be disturbed.

Figure 2: Dune Walkover Design

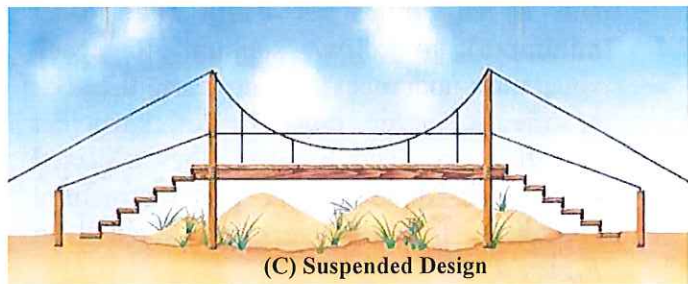
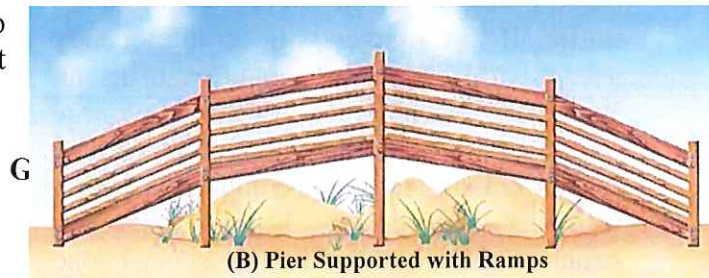
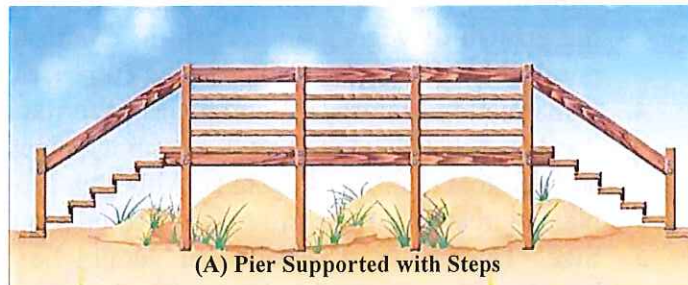

Refer to Dauphin Island Zoning Ordinance Article 7 Section 5 for additional information.

1. Utilize open fence surface designs (split rail fence or chain link fence) and follow existing grades.
2. Handheld tools are recommended for digging fence posts and all other single pole items (flag pole, mailbox, sign, utility pole, birdhouse, birdfeeder, basketball hoop and yard art, etc.).

*Source: Dune Protection and Improvement Manual
Texas Land Office*

3. If the contour of the dune is disturbed, it must be restored to the pre-construction profile.

H. Re-Vegetation and Stabilization of Disturbed Areas

Refer to Section 11 of this Article for a list of appropriate vegetation species and guidelines.

1. Utilize native tree, shrub, grass, and wildflower species that represent those species which were removed (or reflect the ecological community in the immediate area) within building and driveway buffers to facilitate maintain and preserve the ecological diversity of the area.
2. Chosen species should be adapted for local soil and climate (temperature, rainfall, hardiness zone).
3. Obtain plants from local nurseries to insure climatic acclimation.
4. Existing trees and plants include (but are not limited to)
 - Myrtle Oak (*Quercus myrtifolia*)
 - Pinebarren Flatsedge (*Cyperus retrosus*)
 - Muscadine (*Muscadinia rotundifolia*)
 - Slash Pine (*Pinus elliotii*)
 - Southern Magnolia (*Magnolia grandiflora*)
 - Live Oak (*Quercus virginiana*)
 - Blue-Eyed Grass (*Sisyrinchium*)
 - Salt Bush (*Atriplex*)
 - Button Bush (*Cephalanthus*)
 - Oleander (*Nerium oleander*)
5. Replace native trees that were removed with appropriate native trees species, with 50% of the trees having a minimum of a 1" caliper measured at 6" above planting line.
6. Vegetation should be planted with the following spacing / density: Hardwoods: 10' X 10', Conifers: 8' X 8', Shrubs: 6' X 6', Grass plugs: 1' X 1'.
7. Re-vegetate in stages as portions of the site are complete. Re-vegetate all areas as soon as possible following completion of construction, not to exceed **2 months** following Certificate of Occupancy.
8. Maintain vegetation for a minimum of 5 years. Vegetation that dies for any reason should be replaced.
9. Avoid all introductions of invasive and exotic species to the landscape.
10. Minimize the width of maintained buffers around buildings (10 ft.) and associated driveways (5 ft.) so that a greater area is vegetated with native species.

I. Trimming Branches and Physical Wounds

1. Make clean cuts with a sharp saw just inside the swollen branch collar.
2. Seal all cuts immediately to prevent disease on all oaks during the growing season. Do not seal cuts for other species when trimming in the dormant season.

J. Removal of Blown Sand

1. Only remove sand deposited on decks, walkways, driveways, carports, manicured lawns, etc. and allow blown sand to remain in other vegetated areas.
2. Utilize snow fencing / sand fencing to establish temporary windbreaks (especially when vegetation is dormant) to “capture” sand and avoid the need for continued removal of blown sand.
3. Within the Dune Protection Overlay District, encroaching sand from the dune system may be removed from lots and is required to be relocated within the dune system, provided that it is placed as near to the excavated site as practicable, as determined by the Building Inspector. Each application for the removal of encroaching sand will be determined on a case-by-case basis. A plan including methods for sand removal, transport and placement will be required to adhere to existing land disturbance regulations and permitting. Removal of additional sand on an annual basis requires a land disturbance permit.

K. Building Foundations

Open foundations are recommended for the Dune Protection Overlay District. Open foundations are constructed in such a manner to allow water and sand to flow freely through them. Open foundations also minimize the total surface area that water and sand may act upon. When compared to closed foundations for the same size building, an open foundation will have lower-magnitude water and sand forces acting on the foundation.

Simply stated, the portion of the foundation above exterior grade is minimal and allows nearly unrestricted movement of water and sand beneath the building. Below-grade foundation components can be described as a deep foundation with deeply driven or jetted piers or caissons or shallow foundations with footings or grade beams. Terms such as ‘deep’ and ‘shallow; are relative and are best used to refer to the maximum scour and erosion anticipated during a design event or during the project life of the building.

***NOTE: All figure numbers and suggested techniques are sourced from FEMA’s Local Officials Guide for Coastal Construction: handbook. They are as follows:**

- **Deep, Open Foundations**-Buildings founded and supported by driven or jetted piles or caissons in deep soil strata generally offer the greatest resistance to coastal hazards. When supported by foundations deep enough to retain sufficient strength to resist flood and sand loads after scour and erosion have removed soils around the foundation, properly constructed buildings can fair well, even when exposed to wind loads, see *Figure 6-1*.

Post-event assessments have revealed success stories, even when building have been exposed to conditions greater than those anticipated during a design event. Unfortunately, post-event assessments of building on deep foundation in coastal areas often reveal failures due to poor construction. Many of these failures result from the use of inadequately designed foundations or inadequate connections between the elevated structure and its foundation.

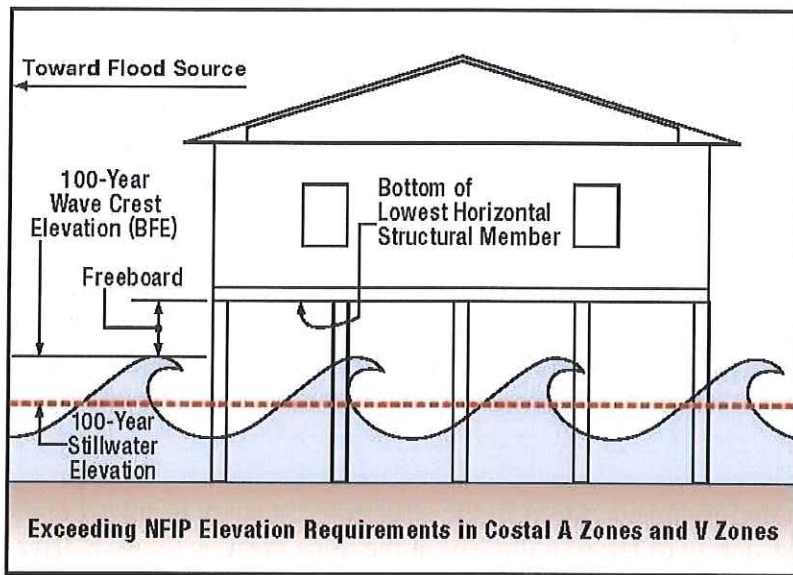

Figure 6-1.
Recommended open-foundation
practice for buildings located
within the Coastal A Zone and
V Zone. (Source: FEMA 55)

- Pile foundations**- consist of deep vertical piles installed to support an elevated structure, see *Figure 6-10*. Because pile foundations are typically set deep within the soil, they are inherently less susceptible to scour and erosion. Piles rely primarily on the friction forces that develop between the pile and the surrounding soils (to resist gravity and uplift forces) and on the compressive strength of the soils (to resist lateral movement and maintain the structure's lateral stability). The soils at the ends of the piles also help resist gravity loads. When the piles rest on their pile tips for load bearing, the designer must show that the soil surrounding the piles provides appropriate lateral stability. Serious consideration should be given by the designer to ensure that the structure is capable of maintaining its lateral stability during a storm event.



Figure 6-10.
DAUPHIN ISLAND, ALABAMA:
Successful pile foundation following
Hurricane Katrina. The foundation
supported the elevated home even
after scour and erosion removed
several feet of soils.
(Source: FEMA 549)

Piles are typically treated wood timbers, steel pipes, or precast concrete members. Other materials, such as fiber-reinforced polyester (FRP), are available but are not commonly used in residential construction. For load pater continuity, consideration should be given to extending the timber piles to the roof level (in single-story buildings) or to the second level (in multi-level buildings). This provides additional stiffness to the structure that reduces undesirable deflection in the building, increases the ability of a building to resist lateral loads, and may reduce the need to cross-brace the piles.

Crucial aspects of a pile foundation include pile size, installation method, embedment depth, bracing and connections to the elevated structure. Inadequate embedment and the use of improperly-sized piles greatly increase the probability of structural collapse. Piles are appropriate for use within all coastal zones when the bearing and lateral capacities are verified by a geotechnical engineer.

The method of installation is a major consideration in the structural integrity of pile foundations. The ideal option when not constructing of top of a dune or at the dune crest, is to use a driven-pile method, as it disturbs the supporting soil around the pile the least amount and results in the highest bearing capacity for each pile. Through this method, the pile is held in place with leads while a single-acting or double-acting diesel- or air-powered hammer drives the pile into the ground.

Driven piles may be set with vibratory hammers or with drop hammers, with drop hammers typically proving to be the less expensive choice. A drop hammer consists of a heavy weight raised by a cable (attached to a power-driven winch) which is then dropped onto the pile.

Jetting is the most frequently used method of inserting piles into sandy soil. Jetting involves forcing a high-pressure stream of water through a pipe that advances with the pile. The water creates a hole in the sand as the pile is driven until the required depth is reached. Unfortunately, jetting loosens the soil that will support the pile and the tip, resulting in a lower load capacity due to less frictional resistance, see *Figure 6-13*.

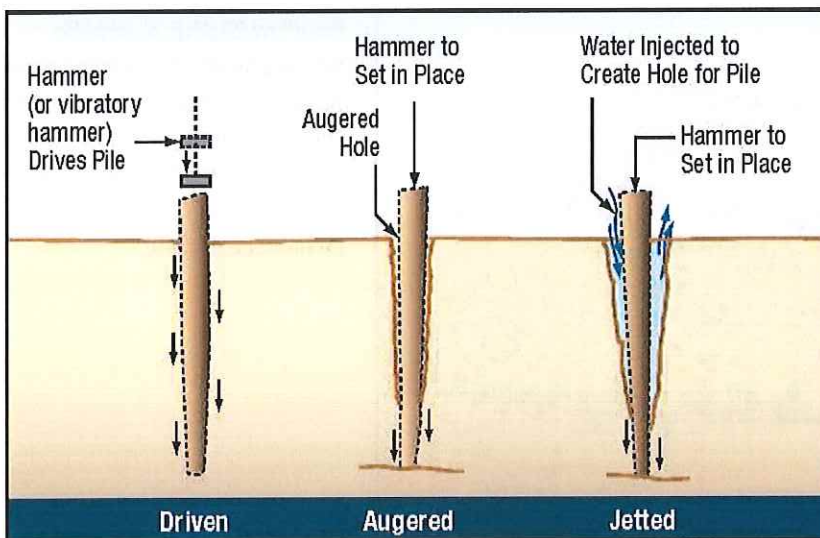

Figure 6-13.
Pile installation methods.
(Source: FEMA 55)

If steel piles are employed, only the driven-pile method should be used. For any pile driving, the authority having jurisdiction, or the engineer-of-record may require that a driving log is maintained for each pile. The log will record the number of blows required per foot as driving progresses. This log is a key factor used to determine pile capacity.

Holes for piles may be excavated by an auger if cohesive soils with sufficient clay or silt content are present to prevent cave-in. Auguring can be used alone or in conjunction with pile driving. If the hole is 'full-sized', the pile is dropped in and the void backfilled. Alternatively, an undersized hole can be drilled, and a pile driven into it. When soil conditions are appropriate, the hole will stay open long enough to drop or drive in a pile. However, when constructing a building on top of a dune or at the dune crest, jetting is the recommended and preferred method to avoid the degradation of the dune due to the use of the heavy equipment required to drive a pile.

- **Wood Pile-to-Beam Connections-** Wood piles are used in many coastal areas for open foundations. These piles are often notched to provide a bearing surface for a beam supporting the house above. When this method is used, the notch should not reduce the pile cross section more than 50 percent (such information is typically provided by a designer on the building plans). A larger pile notch than 50 percent will result in a reduced capacity to carry lateral loads at the connection. Also, for proper support of vertical loads, the beam should bear on the surface of the pile notch.

Post-disaster investigations have observed that the wood-pile-to-beam connection point has been a critical link. If there is a poor connection at the point where the top of the pile connects to the building itself, failure may occur. An engineer should design the connection between a wood pile and the elevated structure. This connection may require pile bracing in order to reduce a pile's unbraced length and maintain a strong connection. Engineers should consider the pile group, the connections, and the floor system (diaphragm) as an entire system. In order to eliminate pile and connection failures, it is important that the floor system and the pile group act as a complete system and not independently.

- **Pile Bracing-**While foundation designs that are free of bracing are preferred, most foundation designs using timber piles rely upon bracing. When installed properly, bracing increases the stiffness of the pile group that (in some cases) may allow for wider spacing of piles beneath the building or smaller diameter piles to be used. The inclusion of bracing increases the axial capacity of a timber pile due to the reduction in unbraced length. Bracing also reduces lateral displacements of the building by stiffening the foundation.

In wood-framed construction, bracing typically involves diagonal cross-bracing. Diagonal cross-bracing consists of long, slender steel rods or dimensional lumber installed diagonally between adjacent piles. Knee braces are shorter members installed between piles and the beams they support. Knee braces extend from the upper portion of the pile to the beams and support the pile in such a manner that the unbraced length of the pile is effectively reduced while allowing the floor system to be elevated as high as possible. Due

to the strength limitations inherent in wood framing, however, some of the proper connections required to transfer the loads are difficult to obtain with wood framing.

Diagonal cross-bracing is the most effective means of bracing a pile to reduce the unbraced pile length, but this method has vulnerabilities when used on coastal foundation applications, see *Figure 6-14*.

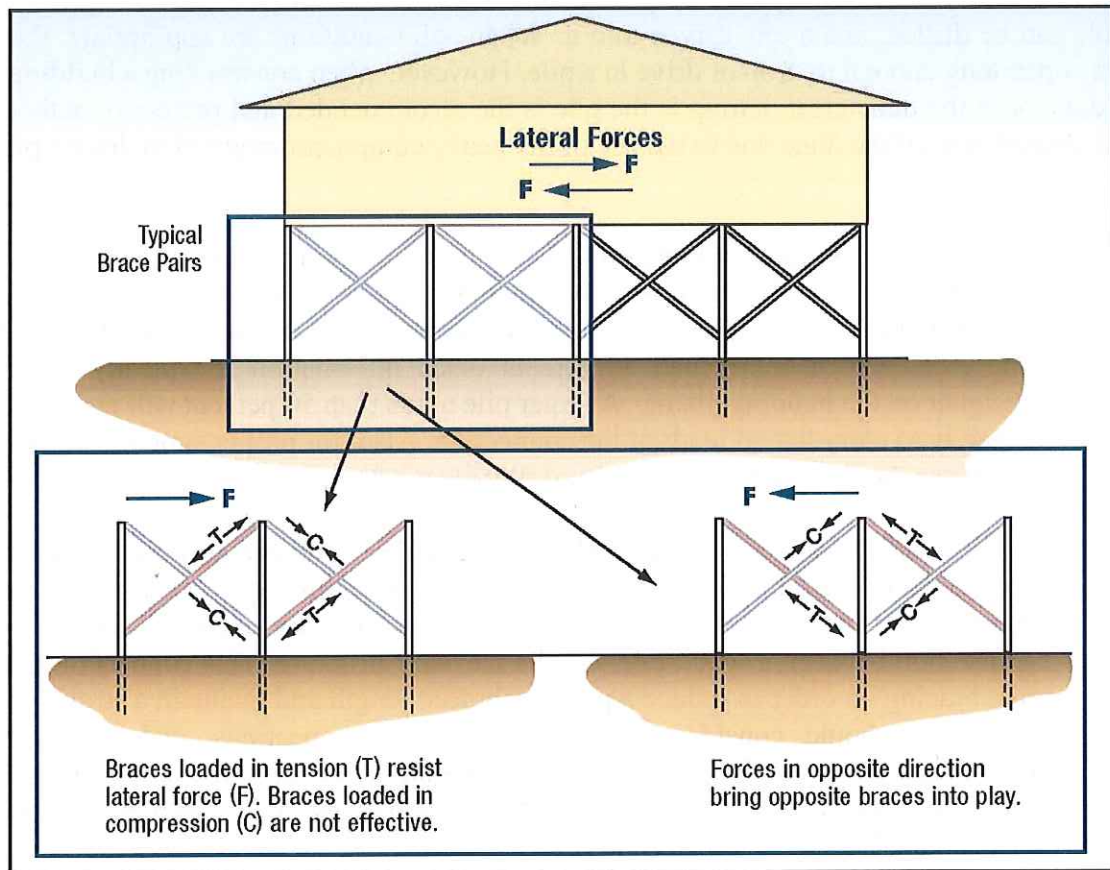

Figure 6-14.
Diagonal bracing schematic. (Source: FEMA 550)

The braces themselves can obstruct moving floodwater and increase a foundation's exposure to impact from waves and debris. Knee-bracing is less vulnerable to flood loads and debris impact but may not provide as much stability and support as diagonal cross-bracing.

Because diagonal braces tend to be slender, these members are susceptible to compression failures; hence most bracing is considered tension-only bracing. Because wind loads and (to a lesser extent) flood loads can act in opposite directions, tension-only bracing must be installed in pairs. One set of braces resists load from one direction while the second set resists loads from the opposite direction. The figure below shows how tension-only bracing

pairs resist lateral loads on a structure. The orientation of the bracing is an important design consideration and it is important that the bracing is constructed in a manner consistent with the plans. Bracing should be oriented parallel to the anticipated direction of the flow of water to reduce the potential for debris dams.

The placement of the bolted connection of the diagonal cross brace to the pile requires considerable judgment. If the connection is placed too high above grade, the pile length below the connection is not braced and the overall bracing will prove less strong and sturdy. If the connection is placed too close to grade, the bolt hole is more likely to be flooded or infested with termites. Because the bolt hole passes through the untreated part of the pile, flooding and subsequent decay or termite infestation may weaken the pile at a vulnerable location. The bolt hole should, therefore, be treated with a preservative after drilling and before bolt placement. Knots and other imperfections in the pile and bracing should also be considered when selecting the connection points.

The use of knee braces involves installing short diagonal braces between the upper portions of the pilings and the floor system of the elevated structure.

The braces increase the stiffness of an elevated pile foundation and can be effective at reducing the lateral forces on a home. While knee braces do not stiffen a foundation as much as diagonal bracing, they do offer some advantages over diagonal braces. For example, knee braces present less obstruction to waves and debris, are shorter than diagonal braces, and are usually designed for both tension and compression loads. Unlike diagonal braces, knee braces do not reduce bending stresses within the piles (in fact, knee braces can actually increase building stresses) and will not reduce the diameter of the piles required to resist lateral loads. The entire load path into and through the knee brace must be designed with sufficient capacity. The connections at each end of each knee brace must possess sufficient capacity to handle both tension and compression and to resist vertical loads in the brace. The brace itself must have a sufficient cross-sectional area to resist compression and tensile loads, see *Figure 6-15*.

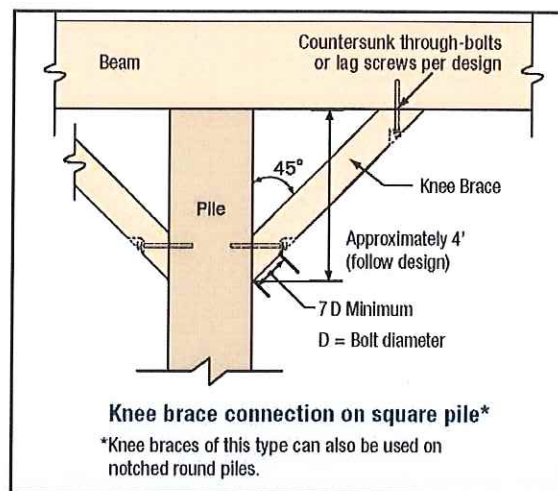

Figure 6-15.
Knee brace connection example.
(Source: FEMA 550)

THIS PAGE INTENTIONALLY LEFT BLANK

SECTION 10 SUGGESTED BEST MANAGEMENT DESIGN AND IMPLEMENTATION

SLOPE STABILIZATION

Development in critical dune areas often requires slope stabilization to minimize impacts and avoid creation of erodible soils. The use of retaining walls for slope stability allows for increased elevations within a short distance; however the design and use must provide resistance to the lateral pressure of the soil. Additional wall support may be achieved through use of mechanical anchors.

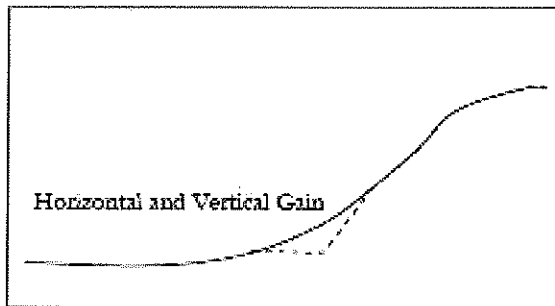

Figure 17A. Dry block. A mortartless stacking of blocks that utilize gravity to maintain vertical stacking and horizontal soil pressure. Stacking provides stabilization for low profiles and stable soils.

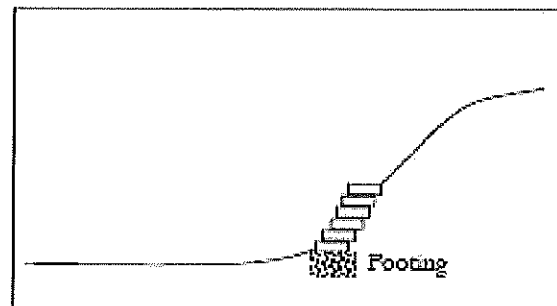

Figure 17B. Stacking of dry blocks requires successive stair stepping into the hillside to maintain integrity. Method allows for minimal slope cutting and is best utilized for stabilizing the "toe" of a slope.

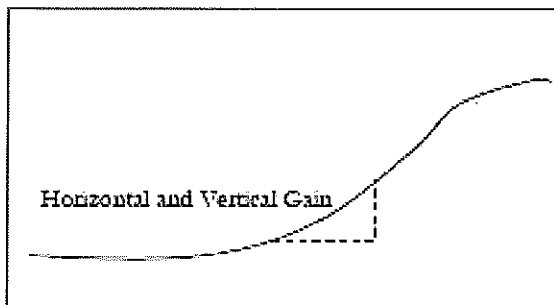

Figure 18A. Mortared Wall. A vertical construction of block, brick, or stone, utilizing mortar to bond materials together vertically and horizontally. Wall provides greater slope stability and increased height.

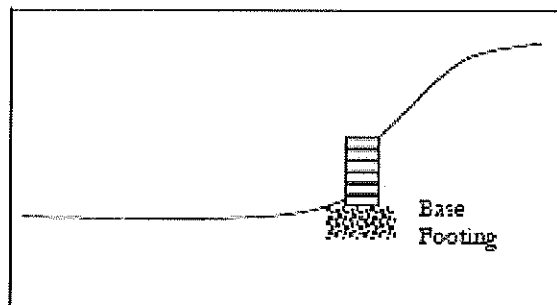

Figure 18B. Mortared walls require significant footings below grade to maintain vertical position. Additional support provided by anchoring into slope for increased height and use in unstable soils.

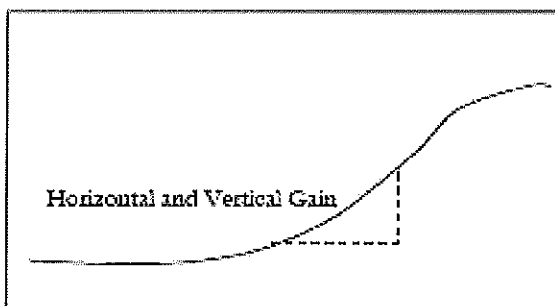

Figure 19A. Timber Wall. A vertical construction of wood lumber supported by vertical posting that acts as a cantilever to counteract horizontal soil pressure. Appropriate designs and soil stability may allow for increased height and slope removal.

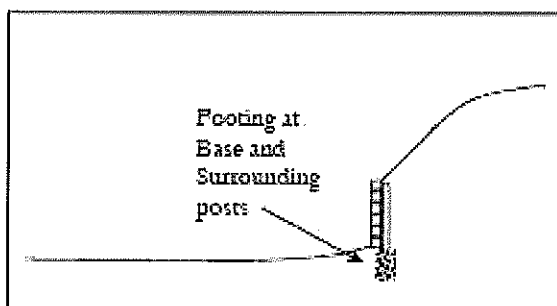

Figure 19B. Timber walls often constructed in board lumber can also utilize horizontal staking of posts (e.g., 6"X6" stock) and bound using timber spikes. Post staking utilizes slope anchors exclusively, whereas timber walls may include vertical posts and slope anchors for sufficient stability.

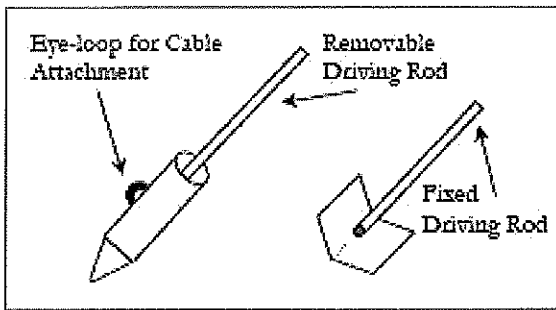

Figure 20A. Earth Anchor. A metal plate or cylindrical tube that pivots on an attached anchoring rod or cable. The loaded anchor planes sideways against undisturbed soil to provide holding strength.

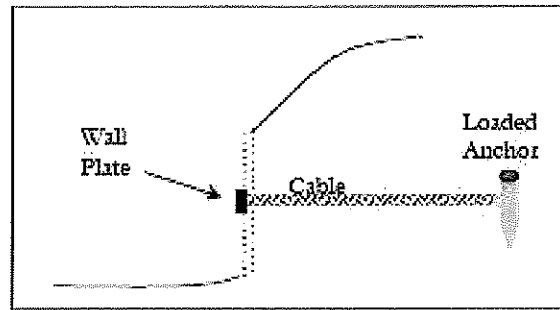

Figure 20B. An earth anchor is driven into the soil and once the driving rod is removed the anchoring rod/cable is pulled to pivot the anchor into a load-lock position.

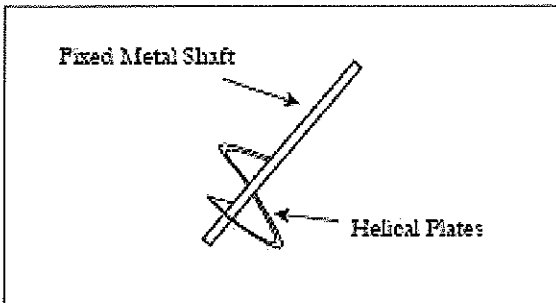

Figure 21A. Helical Anchor. A metal helical plate(s) attached to a metal shaft. Helical plates cut through soil sublayers with minimal surface disturbance.

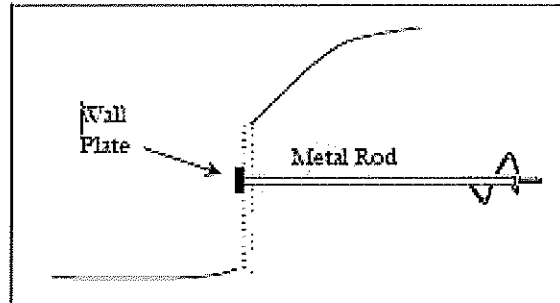

Figure 21B. A helical anchor is screwed into the soil to the appropriate depth and reverse tension is applied to set anchoring position.

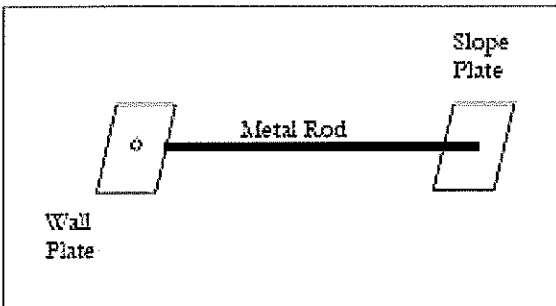

Figure 22A. Cross Plate Anchor. A double plate anchoring system connected by a metal rod. Rod is driven through undisturbed soils to connect plates.

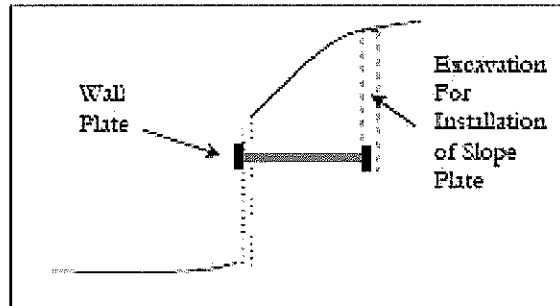

Figure 22B. Plate anchors require excavation of a vertical hole to connect soil plate to metal rod. Plate surface area proportional to holding strength.

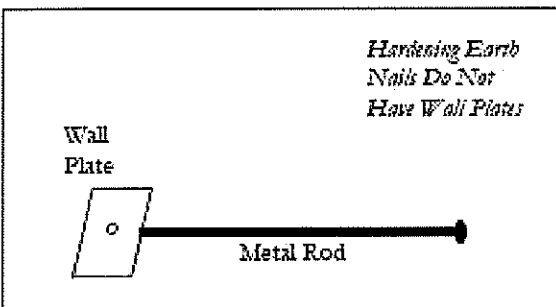

Figure 23A. Earth Nail. A series of metal pins or drilled holes filled with a hardening material to utilize soil resistance in stable undisturbed soils.

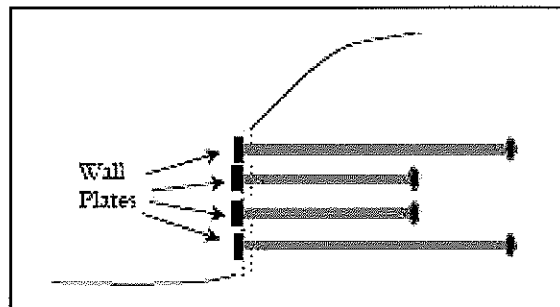

Figure 23B. Nails utilized in stable soils with sufficient soil resistance. Hardening materials may assist in bonding to soils.

SECTION 11 RECOMMENDED DUNE VEGETATION SPECIES AND REPAIR AND/OR MAINTENANCE GUIDELINES

Dune vegetation is essential because it traps blowing sand particles which accumulate and create a mound or a dune that grows over time. Any pre-approved construction-stage, temporary alteration of the dune or dune vegetation must be repaired after completion. If re-vegetation is necessary, the dune must be re-stabilized with native dune plants. These requirements must be completed, inspected, and approved prior to the issuance of a Certificate of Occupancy.

- A. Before a dune is disturbed, it must be photographed along with the vegetation present on the dune in the area to be disturbed. In repairing damage to the dune, the pictures and documentation of the varieties of vegetation originally present on the dune will be useful in restoring the dune to its original condition.
- B. In the event damage has already occurred to the dune, use the same procedure as described above (photograph and documentation of vegetation) using the adjacent portion of the dune to determine how the damaged portion is to be repaired.
- C. Dune vegetation will often vary with dune elevation. Vegetation on the crest of the dune will almost certainly be different from the vegetation on the toe and the rise. It is important to record this distinction to restore the same vegetation that is/was naturally occurring on the dune.
- D. Plants that are indigenous to dunes on Dauphin Island are as follows:

Dune Toes - Salt Water Tolerant

- Sea Oats (*Uniola paniculata*)
- Seaside Heliotrope (*Heliotropium cavsavicum*)
- Pennywort (*Hydrocotyle bonariensis*)
- Seaside Panicgrass (*Panicum amarum*)
- Camphor Plant (*Heterotheca subaxillaris*)



Sea Oats



Pennywort

Fresh Water Aquafers That Form the Toe of the Dunes

- Seaside Heliotrope (*Heliotropium cavsavicum*)
- Seaside Panicgrass (*Panicum marum*)
- Sandspur (*Cenchrus tribuloides*)
- Sea Purslane (*Sensivium portulscastrum*)
- Camphor Plant (*Heterotheca subaxillaris*)
- Beach Morninglory (*Ipomoea stolonifera*)
- Dune Sunflower (*Helianthus debilis*)
- Blazing Star (*Liatris graminifolia*)
- Lantana (*Lantana camara*)
- Dune Greenbriar (*Similax avriculiata*)
- Southern Bayberry (*Myrica cerifera*)



Sandspur

Source: Flickr.com

- Odorless Bayberry (*Muyrica inodora*)
- Saw Palmetto (*Serenoa repins*)
- Cabbage Palm (*Sabal palmetto*)
- Dwarf Palmetto (*Sabal minor*)



Saw Palmetto

Tall -Typically Undisturbed Dunes of the Island's Wooded Areas

- Seaside Panicgrass (*Panicum amarum*)
- Sandspur (*Cenchrus tribuloides*)
- Blazing Star (*Laitris gramimifolia*)
- Sandhill Rosemary (*Ceratiola ericoides*)
- Lantana (*Lantana camara*)
- Dune Greenbriar (*Smilax avricuiata*)
- Sand Pine (*Pinus clausa*)
- Cabbage Palm (*Sabal palmetto*)
- Dwarf Palmetto (*Sabal minor*)
- Cactus
- Century Plant (*Agave aericana*)



Dune Cactus



Beach Morning Glory

E. Sand Fences- The sand fence, consisting of wooden horizontal 1"x4" members, 1/2"x3" wooden slats, sand webbing, and 4'X4' posts sunk 4' up and 4' high will typically slow wind speed by 70% allowing the sands/detritus to drop to the ground and build dune beginnings that will support the vegetation listed as "foredunes". As the foredunes increase in elevation, the back of the dunes will be replenished and ultimately allow the reformation of the Great Dunes.



Sandhill Rosemary

F. Wattles- Utilize wattles made of straw and wood as an erosion and sediment control device. Appropriately designed and properly installed erosion control techniques can eliminate soil and/or sand erosion, reduce sediment pollution, and minimize future impacts to slopes. When long-term stabilization methods are in the form of plantings, wattles and sand fencing are strongly encouraged and, in some cases, required.



Sand Fence



Fabric Fencing



Wattle

Source: miseagrant.edu

SECTION 12 REQUIRED FORMS AND FEES

1. List of Application Packet Content
2. List of Streets in the District
3. Overlay Map
4. Links to Forms Used (if online) including:
5. Planning Commission Review Application ([link](#))
6. Land Disturbance Ordinance & Application ([link](#))
7. Tree Ordinance & Application Form ([link](#))
8. ADEM permit if applicable

THIS PAGE INTENTIONALLY LEFT BLANK

ARTICLE 11
ZONING ADMINISTRATION

SECTION 1 DUTIES AND POWERS OF THE ZONING ENFORCEMENT OFFICER

A. Zoning Enforcement Officer

The Zoning Enforcement Officer shall be the Municipal Building Inspector as designated by the Town Council whose duties shall be as follows:

1. The Zoning Enforcement Officer is authorized and empowered on behalf and in the name of the Council to administer and enforce the provisions of this Ordinance to include receiving applications, inspecting premises, and issuing Certificates of Zoning Compliance and Certificates of Occupancy for uses and structures which are in conformance with the provisions of this Ordinance.
2. The Zoning Enforcement Officer does not have the authority to take final action on applications or matters involving variances, nonconforming uses or other exceptions which this Ordinance has reserved for public hearings before the Board of Adjustment, the Planning Commission and/or the Town Council.
3. The Zoning Enforcement Officer shall keep records of all and any permits, the Certificates of Occupancy issued, maps, plats and other documents with notations of all special conditions involved. He shall file and safely keep copies of all sketches and plans submitted, and the same shall form a part of the records of the office and shall be made as a public record.

B. Permits and Certificates

Permits and certificates shall be issued in accordance with the following provisions:

1. Building Permits: It shall be unlawful to commence the excavation for or the construction of any building or other structure, including accessory structures, or to store building materials or erect temporary field offices, or to commence the moving, alteration, or repair of any structure, including accessory structures, until the Building Inspector of the municipality has issued for such work a building permit including a statement that the plans, specifications and intended use of such structure in all respects conforms with the provisions of this Ordinance. Application for the building permit shall be made to the Building Inspector of the municipality on forms provided for that purpose.
2. Approval of Plans and Issuance of Building Permit: It shall be unlawful for the Municipal Building Inspector to approve any plans or issue a building permit for any excavation or construction until he has inspected such plans in detail and

found them in conformity with this Ordinance. To this end, the Municipal Building Inspector shall require that every application for a building permit for excavation, construction, use of land, moving or alteration be accompanied by a plan or plat drawn to scale and showing sufficient detail to enable the Building Inspector to ascertain whether the proposed excavation, construction, use of land, moving or alteration is in conformance with this Ordinance:

- (a) The actual shape, proportion and dimensions of the lot to be built upon.
- (b) The shape, size and location of all buildings or other structures to be erected, altered or moved and of any building or other structures already on the lot.
- (c) The existing and intended use of all such buildings or other structures.

If the proposed excavation, construction, moving or alteration as set forth in the application are in conformity with the provisions of this Ordinance, the Building Inspector of the Municipality shall issue a building permit accordingly. If an application for a building permit is not approved, the Building Inspector of the municipality shall state in writing on the application the cause for such disapproval. Issuance of a building permit shall, in no case, be construed as waiving any provision of this Ordinance.

- 3. Certificate of Occupancy: No land or building or other structure or part thereof hereafter erected, moved or altered in its use shall be used until the Building Inspector of the municipality shall have issued a Certificate of Occupancy stating that such land or structure or part thereof is found to be in conformity with the provisions of this Ordinance. Within three (3) days after the owner or his agent has notified the Building Inspector of the municipality that a building or premises or part thereof is ready for occupancy or use, it shall be the duty of the Building Inspector of the municipality to make a final inspection thereof, and to issue a Certificate of Occupancy if the building or premises or part thereof is found to conform with the provisions of this Ordinance or, if such certificate is refused, to state the refusal in writing with the cause.

SECTION 2 BOARD OF ADJUSTMENT

The Board of Adjustment, Town of Dauphin Island, Alabama, consists of five (5) members appointed by the Town Council of Dauphin Island, Alabama, for overlapping terms of three (3) years. In addition, two supernumerary members are appointed to serve at the call of the Chairman only in the absence of regular members. Such members are appointed for three (3) years and shall be eligible for re-appointment.

A. Vacancies

Any vacancy in the membership shall be filled for the un-expired term in the same manner as the initial appointment. Members shall be removable for cause by the Town Council upon written charges and after public hearing thereon.

B. No members may hold any other public office or position, except that one member shall be a member of the Town Council.

C. Rules of Procedure

The Board of Adjustment shall observe the following procedures:

1. Said Board shall adopt rules in accordance with the provisions of this Ordinance for the conduct of its affairs.
2. Said Board shall elect one (1) of its members, other than a member of the Planning Commission, as Chairman, who shall serve for one (1) year or until he is re-elected or his successor is elected. Said Board shall appoint a Secretary.
3. The meetings of said Board shall be held at the call of the Chairman and at such other times as said board may determine. The Chairman, or in his absence, the acting Chairman, may administer oaths and compel the attendance of witnesses by subpoena.
4. All meetings of said Board shall be open to the public.
5. Said Board shall keep minutes of its proceedings, showing the vote of such member upon each question, or if absent or failing to vote, indicating such fact, and shall keep records of its examinations and other official actions, all of which shall be immediately filed in the office of the Clerk and shall be a public record.

D. Duties and Powers

The Board of Adjustment shall have the following duties and powers:

1. Administrative Powers: To hear and decide appeals where it is alleged there is error in any order, requirement, decision or determination made by Zoning

Enforcement Officer or other administrative official, in the enforcement of this Ordinance.

2. Special Exception: To hear and decide special exceptions of the terms of this Ordinance upon which said Board is required to pass under this Ordinance.
3. Variances: To authorize upon appeal in specific cases such variance from the terms of this Ordinance as will not be contrary to the public interest where, owing to special conditions, a literal enforcement of the provisions of this Ordinance will, in an individual case, result in unnecessary hardship, so that the spirit of this Ordinance shall be observed, public safety and welfare secured and substantial justice done. Such variance may be granted in such individual case of unnecessary hardship upon a finding by the Board of Adjustment that:
 - a. There are extraordinary and exceptional conditions pertaining to the particular piece of property in question because of its size, shape or topography;
 - b. The application of the Ordinance to this particular piece of property would create an unnecessary hardship;
 - c. Such conditions are peculiar to the particular piece of property involved; and,
 - d. Relief, if granted, would not cause substantial detriment to the public good or impair the purpose and intent of this Ordinance; provided, however, that no variance may be granted for a use of land or building or structure that is prohibited by this Ordinance.

SECTION 3 PROCEDURE FOR REQUESTING A HEARING

A. Procedures

Request for a hearing before the Board of Adjustment for an administrative review, special exception or a variance shall observe the following procedures:

1. An application specifying the reason(s) for an appeal from a decision rendered in writing by the Building Inspector must be filed within thirty (30) days after such written decision has been served upon the applicant.
2. Service by first class mail to the address given on the application shall be deemed sufficient. Applicants shall be advised of this appeal deadline in the written decisions upon their applications.
3. An application shall be accompanied by an acceptable site plan with such reasonable information shown thereon as may be required by the Zoning Enforcement Officer. Such site plan shall include, as a minimum, the following: lot dimensions with property line monuments located thereon; locations and size of existing and proposed structures; yard dimensions and the use of structures; easements (private and public) water course, and if existing and proposed, fence, street names and street right-of-way lines; and such other information regarding abutting property as directly affects the application.
4. The Board of Adjustment shall schedule a meeting to hear an appeal within forty-five (45) days after the date of receipt of an application. Public notice of the hearing shall be given by all of the following methods:
 - a. A printed notice in one or more newspapers of general circulation in the area affected by the appeal, in conformance with applicable state law and at least fifteen (15) days prior to the date of the hearing; such notice shall be printed in a type size easily readable by a person with normal vision.
 - b. Notice by registered mail to the owners of all abutting property on the same side of the street, across the street, and to the rear of the affected property.
5. The Board of Adjustment shall render a decision on any appeal or other matters before it within forty-five (45) days from the date of the public hearing on it. Decisions of the Board of Adjustment shall become effective immediately if rendered in the presence of one (1) or more of the applicants or their representatives. If a decision is rendered in the absence of any of the applicants or their representatives, the decision shall become effective upon service of written notice of the decision upon the applicants by first class mail to the applicants addresses as indicated upon their application. The applicants shall be deemed to have been served three (3) days after mailing of the notice to them. When an applicant receives an adverse decision from the Board of Adjustment, he or she

shall be advised of the fifteen (15) day time limit for taking an appeal to Circuit Court.

6. An appeal stays all legal proceedings in furtherance of the action appealed from, unless the Zoning Enforcement Officer certifies to the Board of Adjustment after the notice of appeal shall have been filed with him that, by reason of facts stated in the certificate a stay would, in his opinion, cause imminent peril to life and property. In such case, proceedings shall not be stayed otherwise than by a restraining order which may be granted by said Board or by a court of record on notice to the official from whom the appeal is taken and on due cause shown.
7. In exercising the powers granted to the Board of Adjustment said Board may, in conformity with the provisions of this Ordinance, reverse or affirm, wholly or in part, or may modify the order, requirements, decisions or determination of the Zoning Enforcement Officer and may issue or direct the issuance of a zoning compliance permit. A concurring vote of four (4) members of the Board shall be necessary to reverse any order, requirement, decision or determination of the Building Inspector or to decide in favor of the appellant in respect to any matter upon which the Board can legally act.

B. Limitation, Withdrawal, Citizen Appeals

1. A property owner, or his appointed agent, shall not initiate action for a hearing before the Board of Adjustment relating to the same parcel of land more often than once every twelve (12) months on the same variance.
2. Any petition for a hearing before the Board may be withdrawn prior to action thereon by the Board at the discretion of the person initiating such a request upon written notice to the Secretary of the Board.
3. Any person or persons severally or jointly aggrieved by any decision of the Board of Adjustment may, within fifteen (15) days thereafter appeal to the circuit court by filing with such board a written notice of appeal specifying the judgment or decision from which appeal is taken.

SECTION 4 PROCEDURE FOR REQUESTING A ZONING AMENDMENT

The Town Council may, from time to time, after examination, review and hold public hearing thereon, amend, supplement or change the regulations and zoning Districts herein or subsequently established.

A. Zoning Amendments

Proposals for zoning amendments, whether initiated by the Town Council, the Planning and Zoning Commission, or any person, firm or corporation, shall be treated in accordance with the following procedure:

1. An application must be submitted on appropriate forms and in writing at least fifteen (15) days prior to the regular monthly meeting of the Planning Commission and, if applicable, must be accompanied by a site plan of the proposed use included in any petition for a zoning amendment.
2. The application shall be sent to the Commission for review and recommendation, and said Commission shall have forty-five (45) days within which to submit a recommendation to the Town Council. If the Commission fails to submit a report within the forty-five (45) day period, it shall be deemed to have approved the proposed amendment.
3. Before enacting any amendment to this Ordinance, a public hearing thereon shall be held by the Planning Commission with proper legal notice published in a newspaper of general circulation in the jurisdiction, at least fifteen (15) days prior to the said public hearing. Notice by mail shall be sent to the owner within three hundred (300) feet of the affected property.
4. The Planning Commission shall post property proposed to be rezoned with a notice at least fifteen (15) days before the public hearing. The posted notice shall set forth the property's present zoning, proposed zoning, the date, time and place of the public hearing. Such notice is to remain in place until final determination by the Town Council.
5. The Council shall hold a public hearing at the earliest possible time under the time limits spelled out above to consider the proposed zoning amendment, and shall take action on said proposed zoning amendment within forty-five (45) days from the date of the public hearing.
6. Any petition for a zoning amendment may be withdrawn prior to action thereon by the Council or Planning Commission at the discretion of the person, firm or corporation initiating such a request upon written notice to the Town Clerk.

